

**SUNSHINE ALUTRADE**  
ALUMINIUM FENCING SUPPLY





# CONTENTS

**03** INTRODUCTION

---

**04** HORIZONTAL SLAT FENCE

---

**06** VERTICAL SLIM FENCE

---

**08** 25x38 BATTEN STRAIGHT FENCE

---

**10** VERTICAL BLADE FENCE

---

**12** PRIVACY WALL FENCE

---

**14** ILLUMINATED GLASS FENCE

---

**16** CUSTOMIZED PRODUCT

---

# INTRODUCTION

## SUNSHINE ALUTRADE

YOUR PARTNER IN HIGH-QUALITY ALUMINIUM MANUFACTURING

Sunshine Alutrade is known for delivering reliable, high-quality aluminium solutions tailored to the needs of various industries. We specialize in crafting custom aluminum products for sectors such as furniture, transportation, and more, with a steadfast commitment to sustainability at every stage of production. By supporting local businesses and fostering strong community ties, we ensure that our operations contribute positively to the local economy while maintaining the highest standards of environmental responsibility. At Sunshine Alutrade, quality, reliability, and sustainability are not just goals—they are the foundation of everything we do.



- Professionalism
- Responsibility
- Convenience
- Innovation
- Proactiveness
- Collaboration

## CORE VALUES



## MISSION

To provide customers with high-quality aluminium products, fabrication services, and project solutions at competitive prices, delivered on time and with a commitment to environmental sustainability.



## VISION

To become a leading and reputable brand in the supply of aluminium fencing systems and the extrusion of bespoke aluminium profiles for the Australian market.

# HORIZONTAL SLAT FENCE

## 01 WOOD GRAIN - COLOR

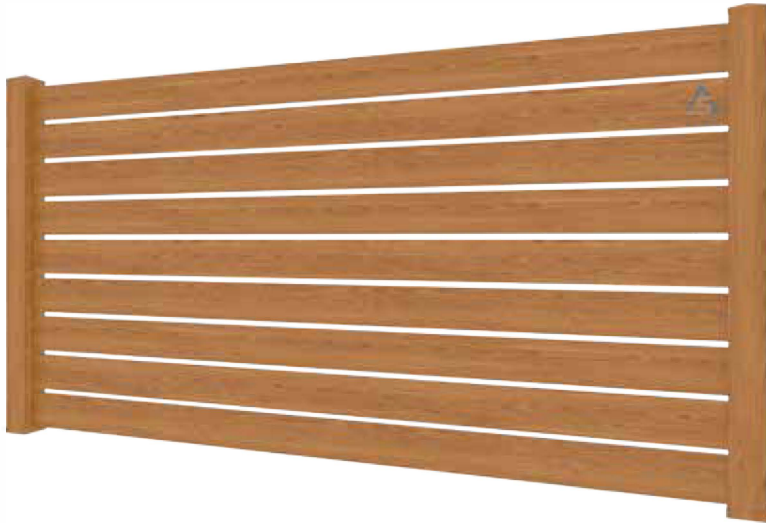

## 02 WHITE - COLOR

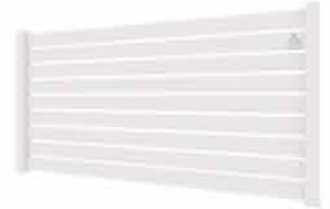

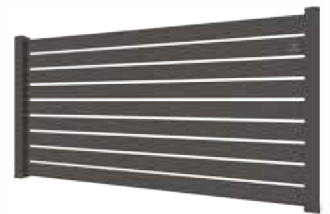

## 03 GREY - COLOR

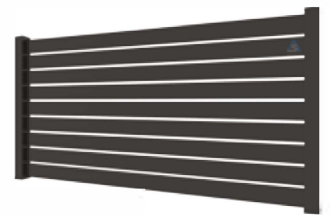

## 04 BLACK - COLOR

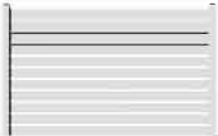

## COMMON SIZE

HEIGHT \ WIDTH	1200	1500	1800	CUSTOM TO ODER
2400				

# SPECIFICATIONS

Average thickness: 1.0 - 2.0 mm

Alloy: 6063 - T5

Width: Max 2400 mm

Height: 1200 mm - 1800 mm

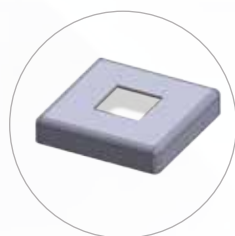
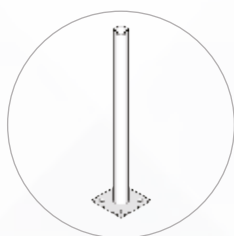
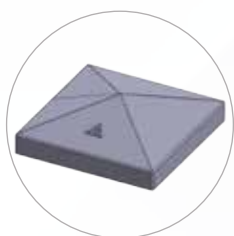
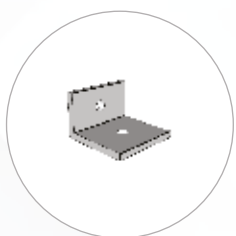
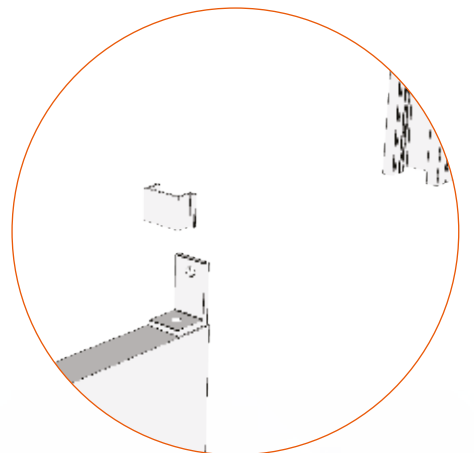
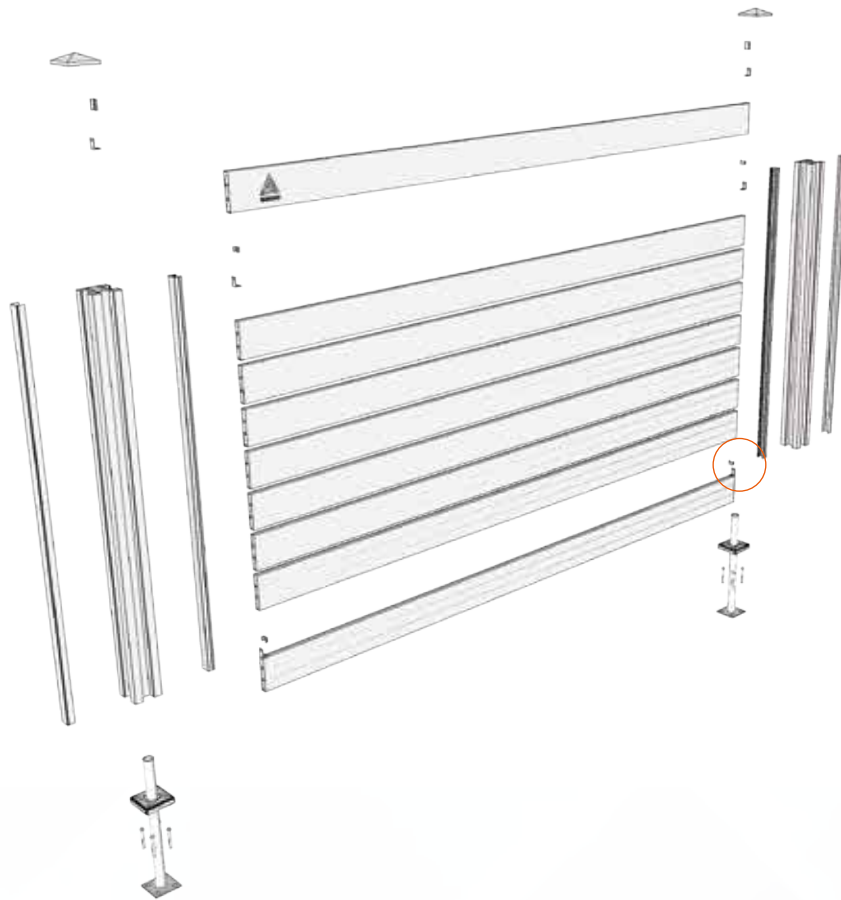
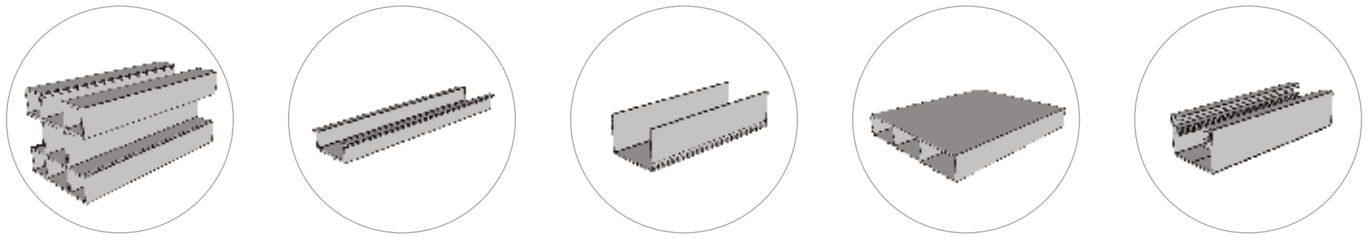

# VERTICAL SLIM FENCE

## 01 WOOD GRAIN - COLOR

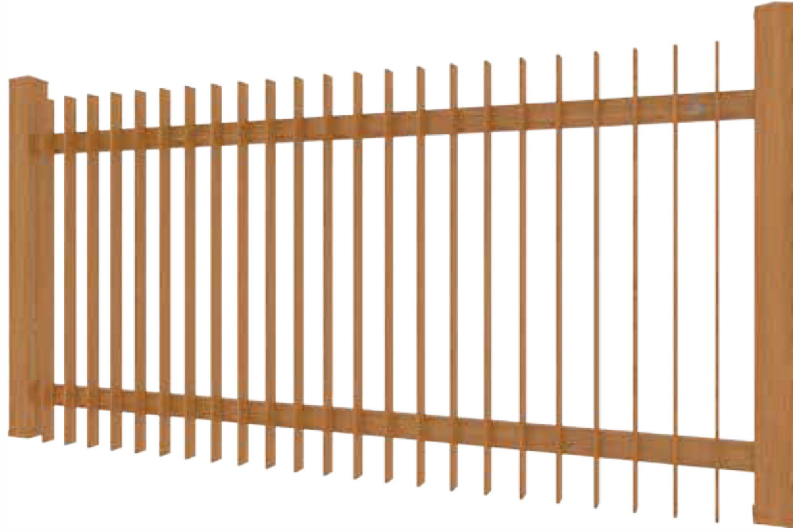

## 02 WHITE - COLOR





## 03 GREY - COLOR



## 04 BLACK - COLOR

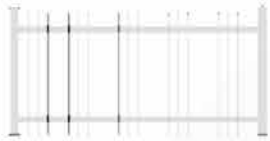

## COMMON SIZE

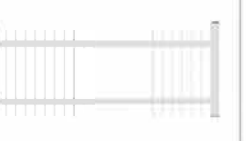
HEIGHT \ WIDTH	1200	1500	1800	CUSTOM TO ODER
2400				

# SPECIFICATIONS

Average thickness: 1.0 - 2.0 mm

Alloy: 6063 - T5

Width: Max 2400 mm

Height: 1200 mm - 1800 mm

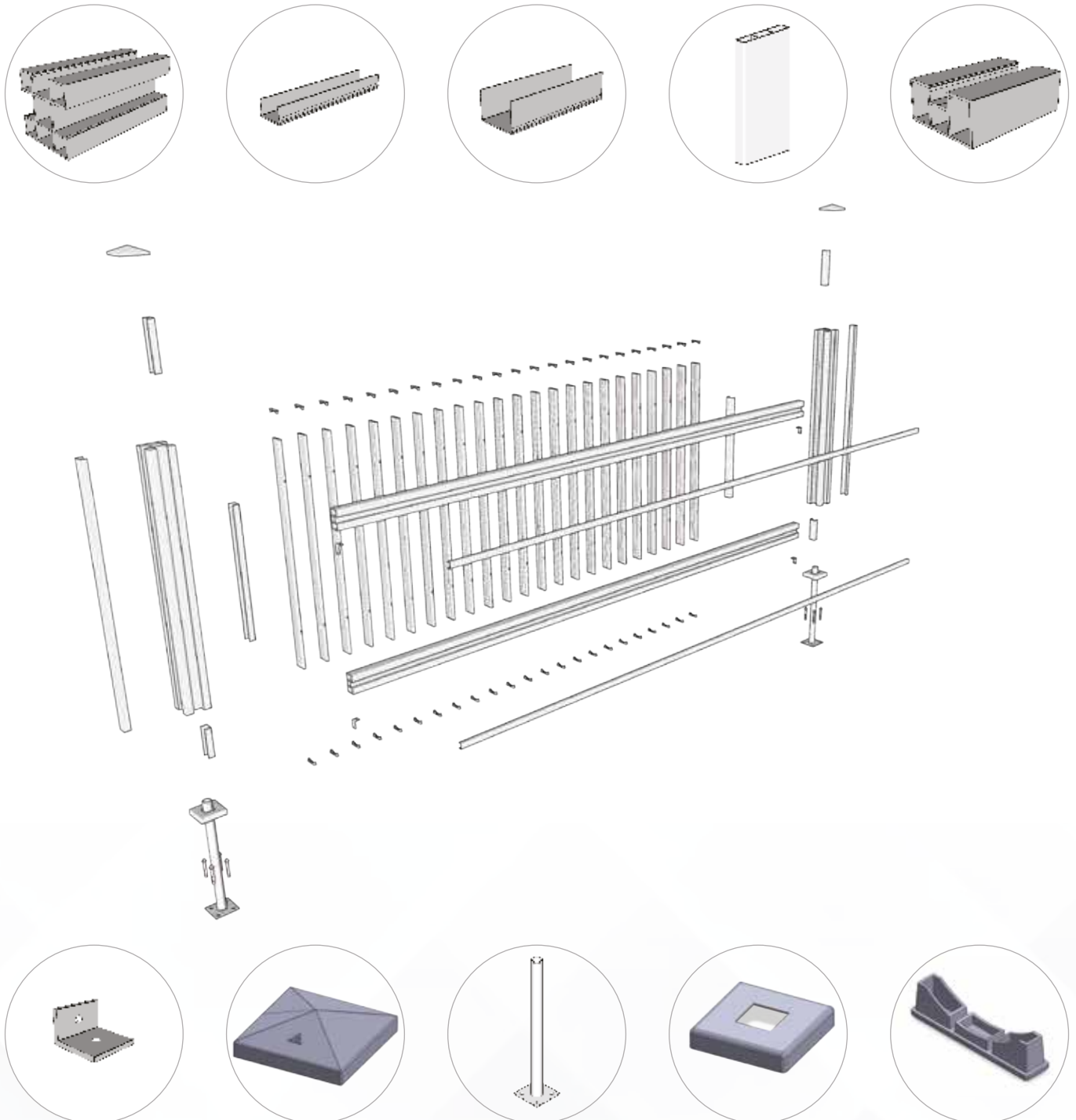

# 25x38 BATTEN STRAIGHT FENCE

**01** WOOD GRAIN - COLOR

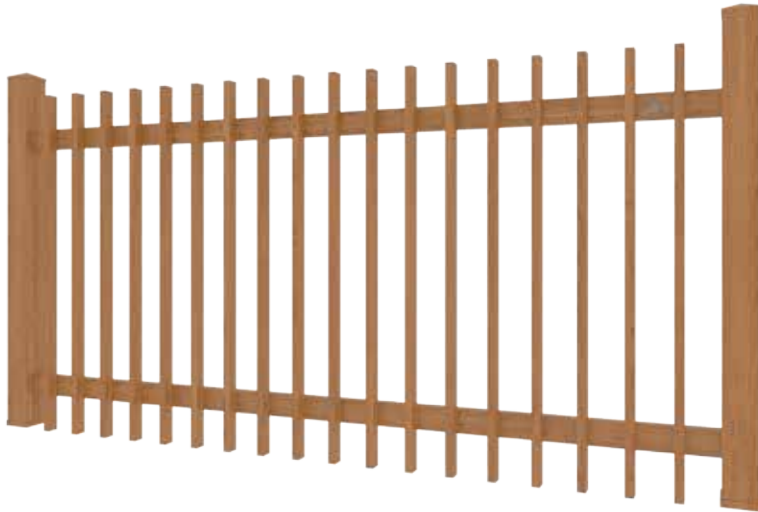

**02** WHITE - COLOR

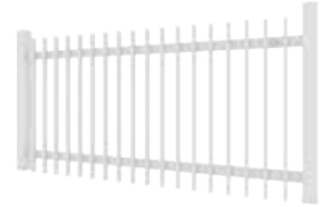

**03** GREY - COLOR

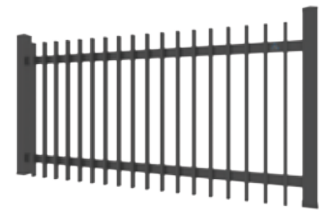

**04** BLACK - COLOR

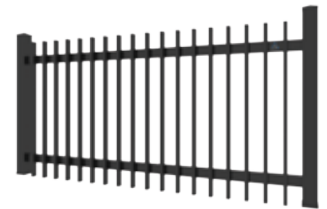

## COMMON SIZE

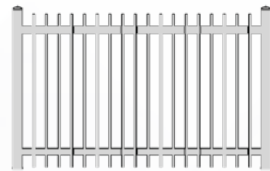
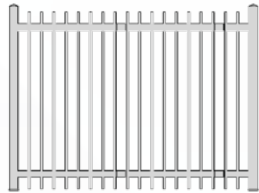
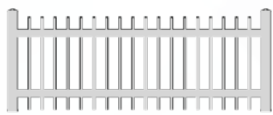
HEIGHT \ WIDTH	1200	1500	1800	CUSTOM TO ODER
2400				

# SPECIFICATIONS

Average thickness: 1.0 - 2.0 mm

Alloy: 6063 - T5

Width: Max 2400 mm

Height: 900 mm - 1800 mm

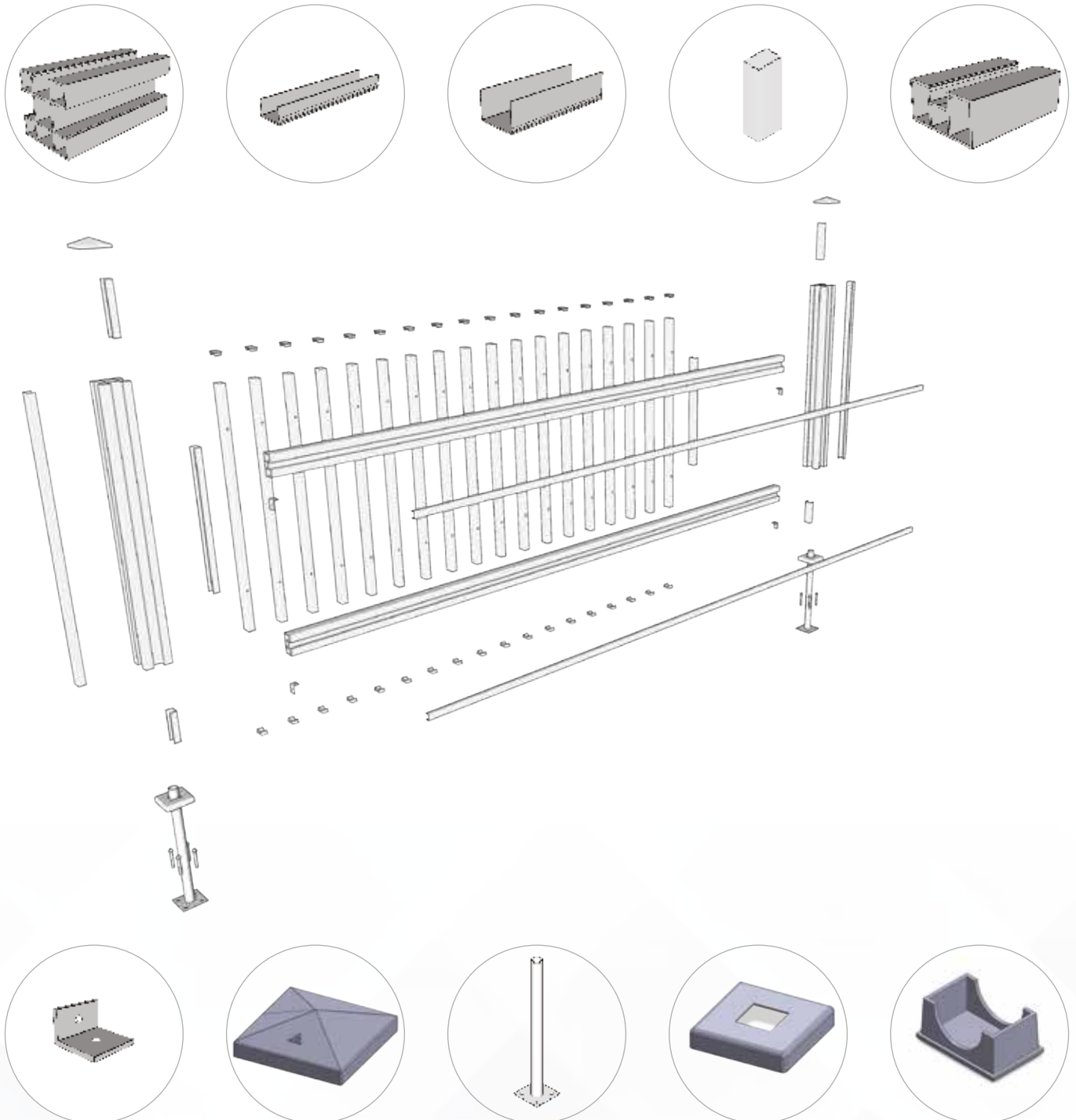

# VERTICAL BLADE FENCE

## 01 WOOD GRAIN - COLOR

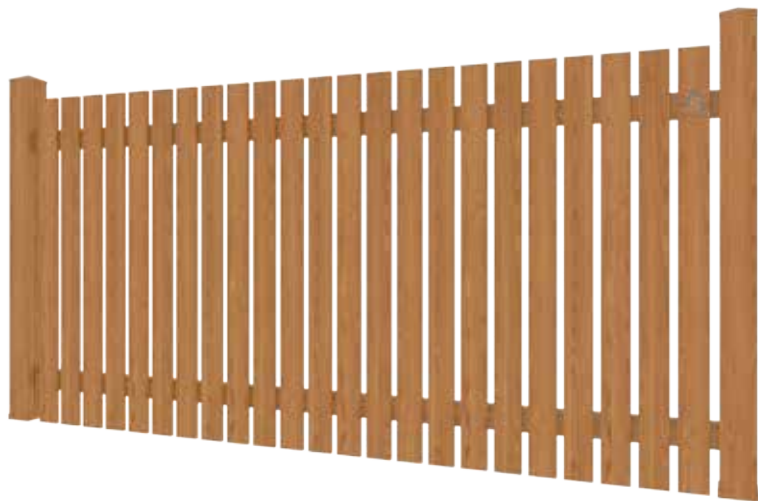

## 02 WHITE - COLOR

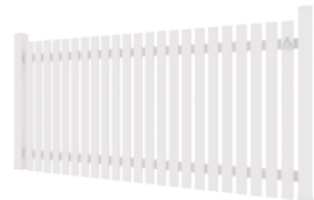



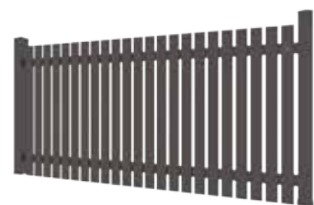

## 03 MONUMENT - COLOR

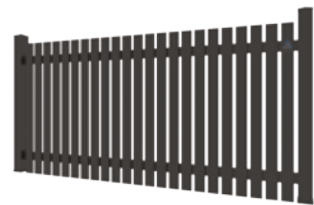

## 04 BLACK - COLOR



## COMMON SIZE

HEIGHT \ WIDTH	1200	1500	1800	CUSTOM TO ORDER
2400				

# SPECIFICATIONS

Average thickness: 1.0 - 2.0 mm

Alloy: 6063 - T5

Width: Max 2400 mm

Height: 900 mm - 1800 mm

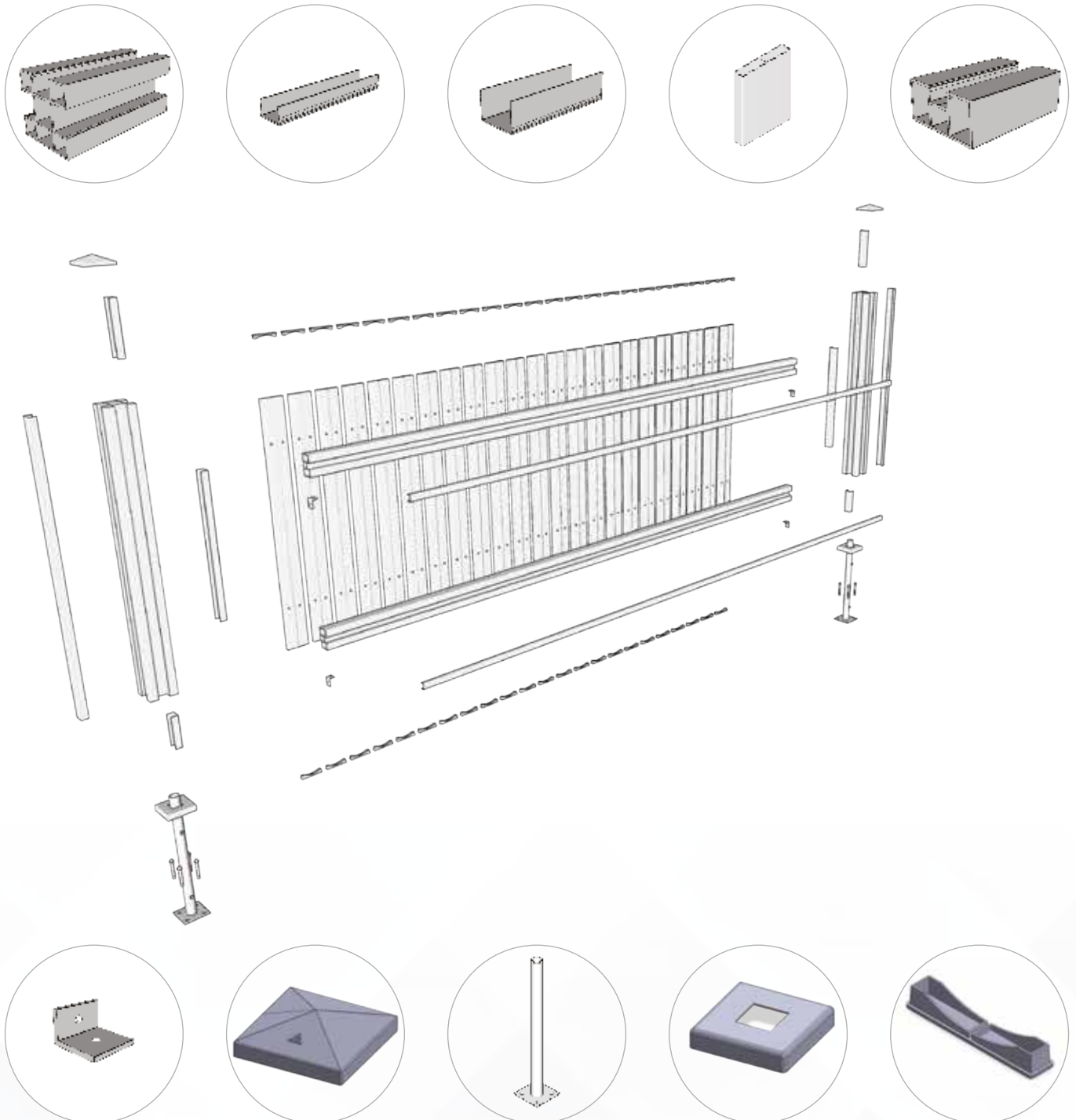

# PRIVACY WALL FENCE

## 01 WOOD GRAIN - COLOR



## 02 WHITE - COLOR



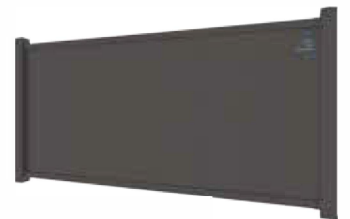

## 03 GREY - COLOR

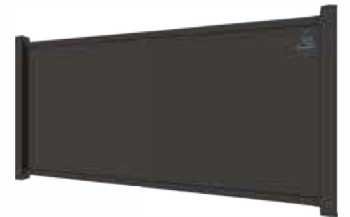

## 04 BLACK - COLOR

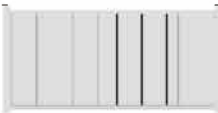

## COMMON SIZE

HEIGHT \ WIDTH	1200	1500	1800	CUSTOM TO ORDER
2400				

# SPECIFICATIONS

Average thickness: 1.0 - 2.0 mm

Alloy: 6063 - T5

Width: Max 2400 mm

Height: 1200 mm - 1800 mm

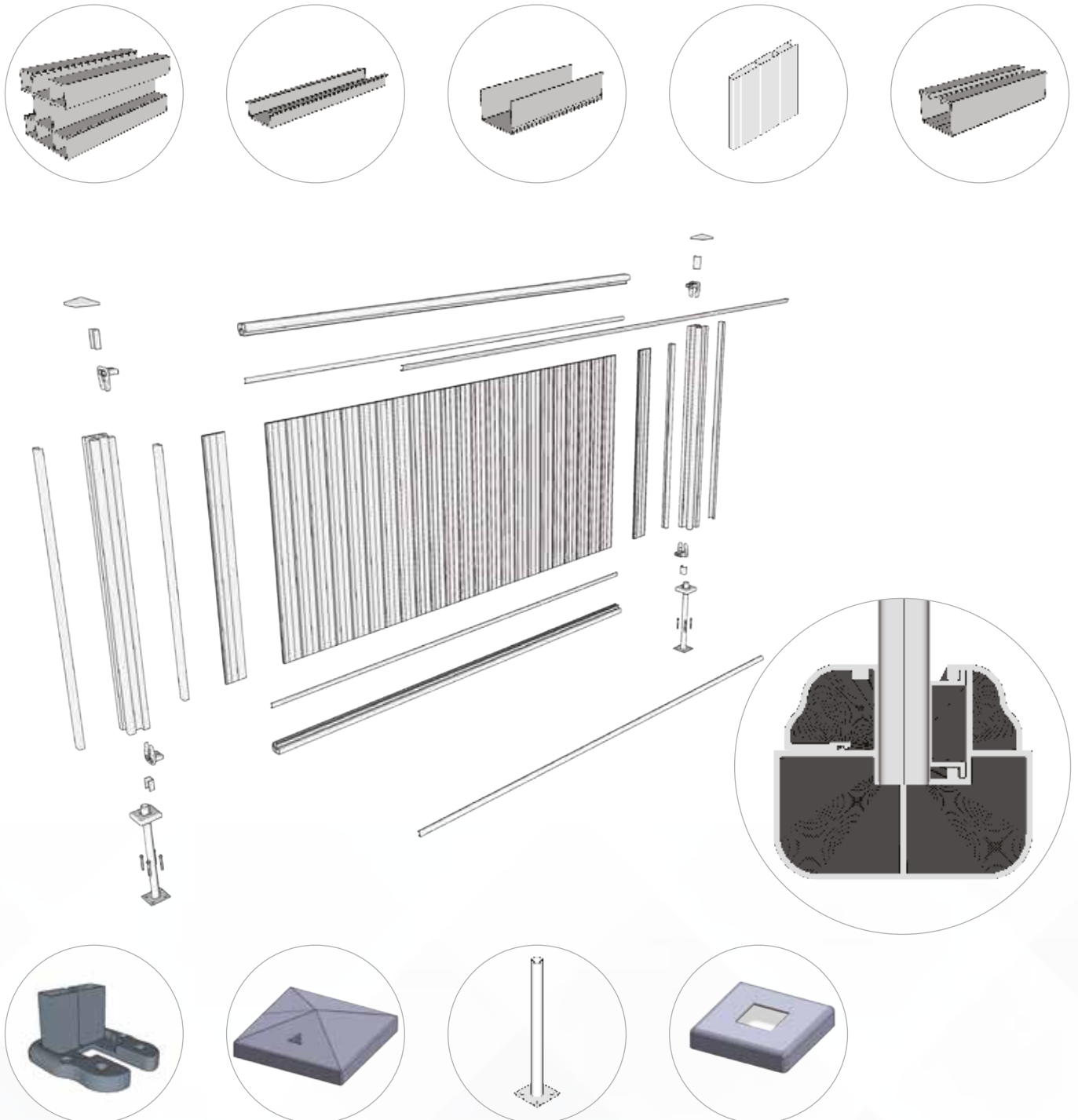

# ILLUMINATED GLASS FENCE

## 01 WOOD GRAIN - COLOR



## 02 WHITE - COLOR



## 03 GREY - COLOR



## 04 BLACK - COLOR



## COMMON SIZE

HEIGHT \ WIDTH	1200	1500	1800	CUSTOM TO ORDER
2400				

# SPECIFICATIONS

Average thickness: 1.0 - 2.0 mm

Alloy: 6063 - T5

Width: Max 2400 mm

Height: 1200 mm - 1800 mm

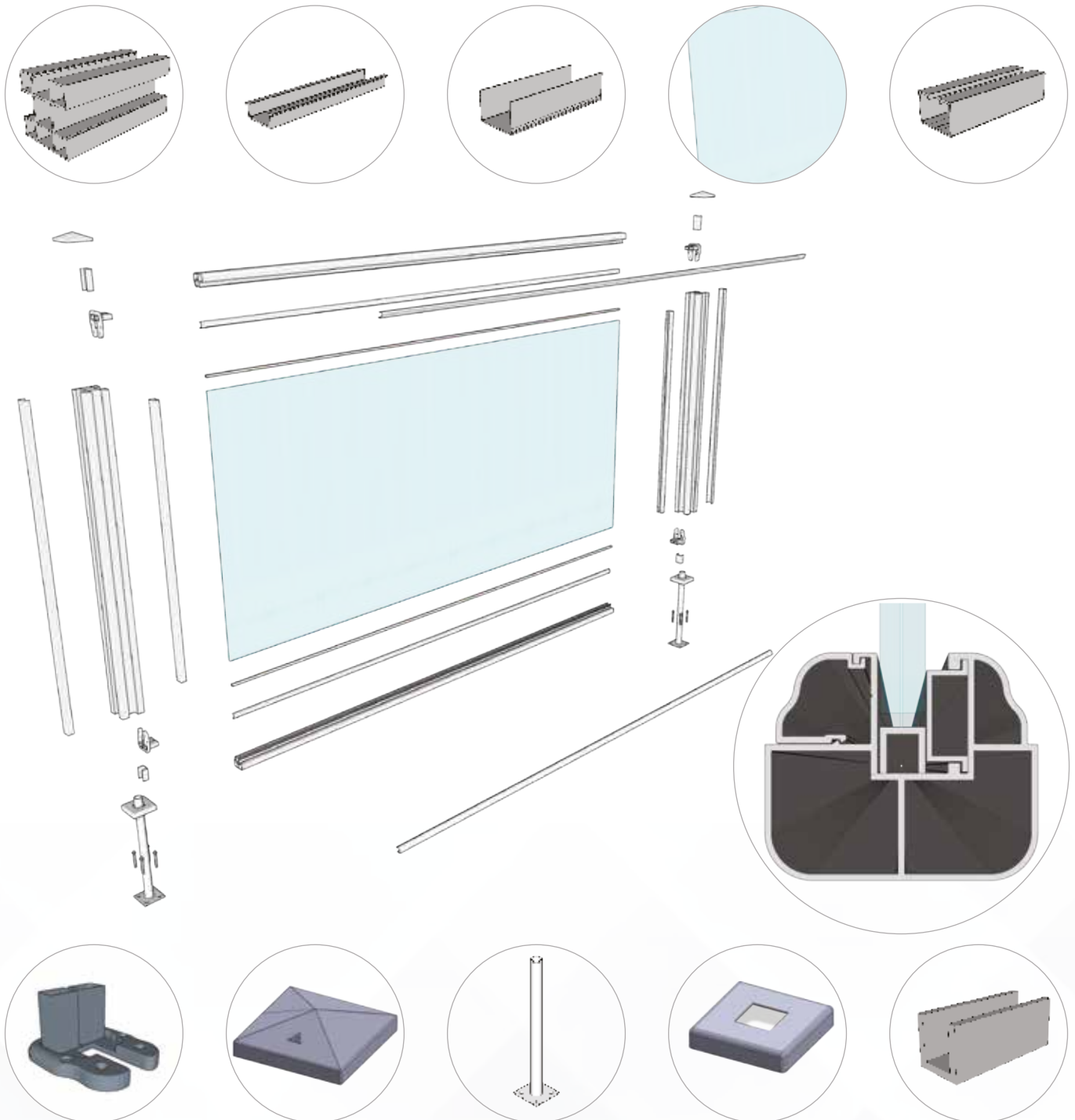

# CUSTOMIZED PRODUCT

## 01 PRIVACY WALL DIAGONAL FENCE - WOOD GRAIN COLOR

---



## 02 PRIVACY WALL FENCE - BLACK & WOOD GRAIN COLOR

---



# 03

VETICAL BLADE FENCE #2 | HR15 + 15x80

---



# CUSTOMIZED PRODUCT

**04** 10x50 BATTEN STRAIGHT FENCE #2 | HR15 + 10x50

---

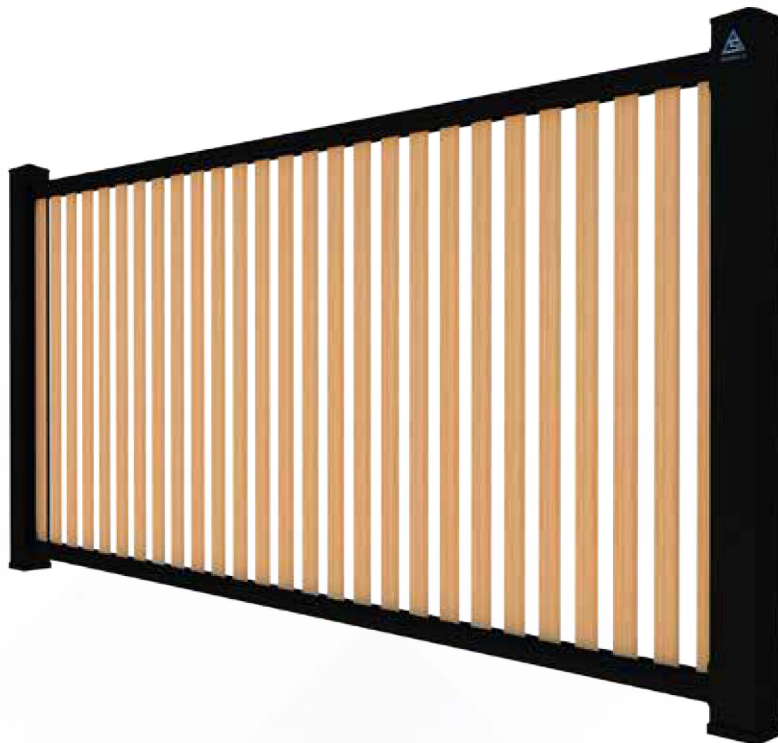



**SUNALU**

***THANK YOU***

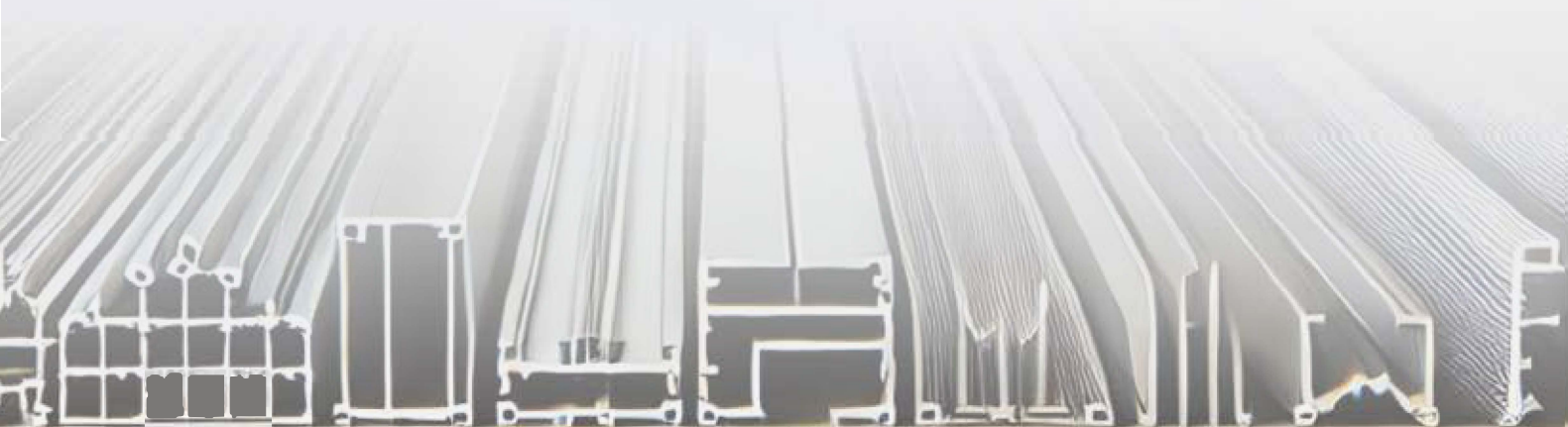



**SUNALU**

**SUNSHINE ALUTRADE**

**Showroom**

📍 1/90 Cranwell Street, Braybrook, VIC 3019, AUSTRALIA

☎ (+61) 490 088 866 - San V Le (Director)  
(+61) 451 306 966 - Tan D Bui (General Manager)

✉ [sanvle@sunshinealuminium.com.au](mailto:sanvle@sunshinealuminium.com.au)  
[tandbui@sunshinealuminium.com.au](mailto:tandbui@sunshinealuminium.com.au)

🌐 [sunshinealuminium.com.au](http://sunshinealuminium.com.au)



**Website**



**FaceBook**